

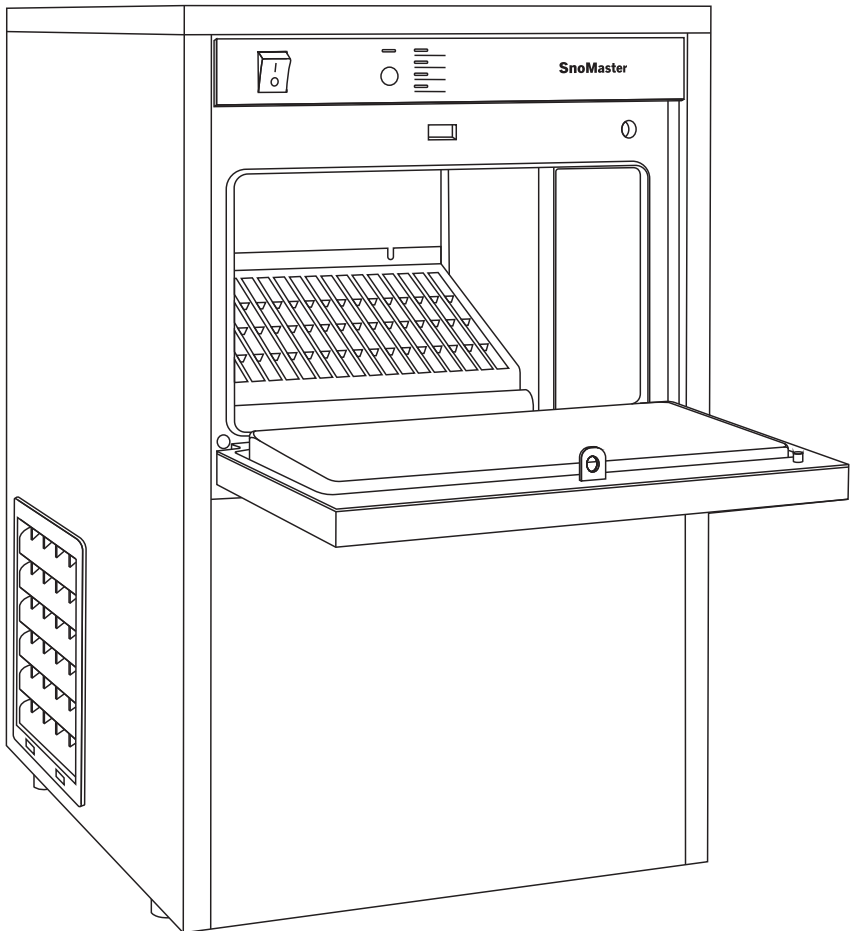

USER MANUAL AND PRODUCT SPECIFICATIONS

ICE COLD ANYWHERE



SMIC-20B

**20KG/24HR PLUMBED-IN
BULLET TYPE ICE-MAKER**

CONTENTS

WARRANTY, SERVICE AND SUPPORT	01
Warranty Registration	
Service and Support	
IMPORTANT SAFETY INFORMATION	02
Critical Safety Information	
Before Using Your Appliance	
PRODUCT FEATURES	04
INSTALLATION INSTRUCTIONS	05
Accessories Included	
Structure	
Operation Procedure	
Control Panel	
MAINTENANCE	11
Cleaning the Interior	
Cleaning the Exterior	
TROUBLESHOOTING	15



THANK YOU FOR PURCHASING THE SMIC-20B, 20KG/24HR PLUMBED-IN BULLET TYPE ICE-MAKER

• WARRANTY, SERVICE AND SUPPORT •

This product is warranted for **2-years from the date of purchase**. Warranty does not cover products that have not been used in accordance with the user guide or are outside the warranty terms and conditions, which can be found at the following url:

<https://snomaster.co.za/warranty/>

WARRANTY REGISTRATION

Register your SnoMaster SMIC-20B, 20Kg/24Hr Plumbed-In Bullet Type Ice-Maker now for warranty, and allow us to provide you with the best possible after sales service:

- Please log onto our website at **www.snomaster.co.za**
- Click on the 'Warranty' tab.
- Enter warranty information and upload proof of purchase at the bottom of the page.

SERVICE AND SUPPORT

Should an instance arise where you require assistance, contact our service team:

- Please log onto our website at **www.snomaster.co.za**
- Click on the 'Support' tab.
- Click 'Find a Repair Agent Near You' and enter your region.
- Alternatively contact us via email: **info@snomaster.co.za** or contact us on **+27 11 392 5315**.

IMPORTANT SAFETY INFORMATION

SMIC-20B, 20KG/24HR PLUMBED-IN BULLET TYPE ICE-MAKER

This manual contains important information including safety, installation, maintenance and warranty instructions of the SnoMaster SMIC-20B, 20Kg/24Hr Plumbed-In Bullet Type Ice-Maker. Please read this manual carefully before use and follow all safety information and instructions. It is recommended to keep this manual for easy reference so that you are familiar with the operation and maintenance of your appliance.

CRITICAL SAFETY INFORMATION

Before using this appliance, ensure it is correctly positioned and installed as outlined in this manual. Follow these basic precautions to prevent the risk of fire, electrical shock, or injury:

- This appliance is designed for domestic indoor use only and is exclusively intended for making ice.
- Ensure that the incline angle of the appliance is not more than 45° during transportation or operation.
- Before using your appliance for the first time, you should wait about 12 hours after positioning it in a place.
- Ensure sufficient personnel are available to move and install the appliance to prevent damage or injuries.
- Installation of this appliance by a certified plumber is recommended.
- The appliance needs to be levelled for optimal operation. You can adjust the appliance feet to level it +/- 10mm.
- For optimal drainage, ensure that the drain outlet is positioned at least 100 millimeters below the ice maker's drainage tube outlet. This arrangement facilitates efficient water outflow by utilizing gravitational force.
- Ensure the plug is easily accessible after positioning the appliance.
- Avoid connecting or disconnecting the electric plug with wet hands.
- To disconnect the appliance, grip the plug and pull it from the wall outlet. Never pull out the plug by the cord.
- It is advisable to use a dedicated power source and avoid using extension cords.

- Please unplug the appliance or disconnect the power before performing any cleaning, maintenance, or servicing.
 - If the appliance power supply cord is damaged, it must be replaced by SnoMaster, its approved agent, or a similarly qualified person to prevent any hazard.
 - It is recommended that the circuit breaker size should be no more than 20 amps.
 - This appliance operates on a single-phase voltage of 220V-240V/50Hz, to avoid electrical surges, it is advised to use a surge protector plug.
 - Cleaning and maintenance should be supervised by adults, especially if children are involved.
 - The appliance should be placed on a flat surface and should be completely unobstructed. Ensure to leave 150mm space around the appliance to ensure proper ventilation for the appliance. Place the appliance away from direct sunlight and heat sources (stove, heater, radiator, etc.).
 - Unless specifically recommended in this manual, do not attempt to repair or replace any part of the appliance. All other servicing should be referred to a qualified technician.
 - Never clean appliance parts with flammable fluids as they may create a fire hazard or explosion. Also, avoid storing or using petroleum or other flammable vapours and liquids near this appliance.
 - Avoid solvent-based cleaning detergents or abrasives on the interior or exterior as they may damage or discolour it.
-

BEFORE USING YOUR APPLIANCE

- Ensure all packaging materials, stickers and films are removed from the product. Clean the appliance's surfaces with a mild detergent and a damp cloth before initial use.
- Before connecting the appliance to a dedicated power source, let it stand upright for approximately 12 hours. This measure helps minimise the risk of cooling-system malfunctions that might occur due to handling during incorrect transportation.
- Ensure all electrical connections are clean and dry before switching on the appliance.
- Ensure all parts are correctly assembled before operation.



This appliance contains R600a refrigerant, which is FLAMMABLE and may cause a fire or an explosion.



WHEN DISPOSING THE APPLIANCE

Please observe the following instructions:

- Always ensure the appliance is out of reach of children.
- Before disposing of it, damage the body to prevent children from climbing inside, ensuring their safety.
- Follow the instructions of your local regulations when disposing.

PRODUCT FEATURES

ICE TYPE: BULLET ICE | SIZE (MM): (H) 40 (W) 27 | 16 ICE BULLETS PER CYCLE | 3.5KG ICE STORAGE BIN | EXTERNAL LED DISPLAY WITH ON/OFF SWITCH | ICE FULL SENSOR | WATER LOW SENSOR | INCLUDES: ICE SCOOP & WATER INLET PIPE

SPECIFICATIONS:

- **Dimensions (mm) Unit:** (H) 590 (W) 470 (D) 380
 - **Dimensions (mm) Packaged:** (H) 695 (W) 530 (D) 440
 - **Ice Type:** Bullet Ice
 - **Ice Size (mm):** (H) 40 (W) 27
 - **Ice Making Capacity:** 20Kg/24h
 - **Ice Production Cycle:** 16 Ice Bullets
 - **Storage Bin Volume:** 3.5Kg
 - **Net Weight:** 25.4Kg
 - **Voltage:** 220V-240V/50Hz
 - **Total Input Power:** 185W
 - **Rated Current:** 1.3A
 - **Suggested Applications:** Small Office, Apartment, Kitchen, B&B, Home Bar, Café, Cocktail Bar
 - **Design Criteria:** Designed for African conditions
-

**WATER INLET ~ WATER FILLING ~ ICE MAKING
~ WATER RELEASING ~ ICE DROPPING**

All these processes are automatically controlled for continuous ice-making.

Should the water supply deplete or the ice storage bin reach capacity, the operational panel's indicator light will activate, and the ice-maker will cease operation automatically. The insulated design of the ice storage bin serves to maintain the ice in a solid state for an extended period.

**Please Note: The ice storage bin is not refrigerated.*

INSTALLATION INSTRUCTIONS



Before installing your new appliance, please read all safety instructions in this manual and follow the installation instructions below:

WATER

- Water treated with reverse osmosis purification often gives a false water indicator, it is advised to fit an inline mineral filter for the sensors to detect the water.
- Ice cycle time is dependent on water temperature. Clean and drain the appliance at least one or twice a month. Lemon juice or 10ml vinegar can be added to the water to help the cleaning process.
- To prevent lime build-up it is advised to clean the appliance with a descaling liquid once a month, dependent on the water quality in your area.



**INSTALLATION BY A CERTIFIED
PLUMBER IS RECOMMENDED**

ACCESSORIES INCLUDED

Please Check If All The Accessories Shown Below Are Included:

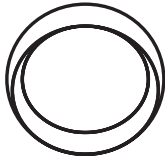

2 x O RINGS TO SEAL THE WATER INLET/ OUTLET PIPES

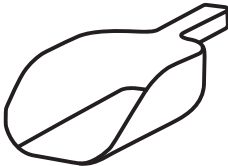

1 x ICE SCOOP

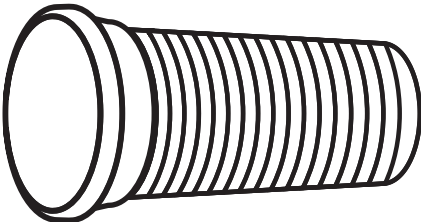

1 x DRAIN OUTLET PIPE

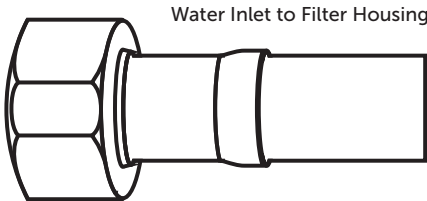

Water Inlet to Filter Housing

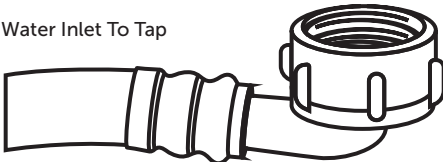

Water Inlet To Tap

1 x LONG WATER INLET

OPERATION PROCEDURE

Installation of this appliance by a certified plumber is recommended

- Remove the appliance from the box and all accessories.
- Ensure the appliance is placed on a level floor for quieter operation.
- Beware that placing the appliance on a carpet may cause the heat from the compressor to cause the carpet to fade.
- To maximize the ice-making performance of our plumbed-in ice-makers, it's ideal to have them in a steady environment with a 20°C ambient temperature and 10°C water temperature. While our ice-makers can handle higher temperatures, these conditions ensure peak production capacity.
- Avoid areas where the appliance might be exposed to direct sunlight, any sources of heat (stove, heater, radiator, etc.), extreme hot ambient temperatures or excessive moisture.
- Place the ice bin protector at the bottom of the ice bin and make sure the drainage hole is not blocked, so the water can drain smoothly.
- Attach one end of the water inlet pipe to the water inlet valve on the back of the appliance. When connecting this pipe, use the sealing washers supplied with the ice-maker to eliminate the risk of a water leak. The other end of the pipe should be connected to one of the filter housing connectors.
- Connect the other water inlet pipe to the other side of the filter housing connector. Connect the other end to a dedicated water supply or tap. When connecting this water inlet, use the sealing washers supplied to eliminate the risk of a water leak.
- Remove the protective plastic film from the filter cartridge prior to installation. Carefully align the cartridge within the filter housing, ensuring it is seated evenly within the designated grooves. Secure the housing lid by screwing it on gently to avoid compromising the integrity of the filter.
- The drain outlet pipe must be fitted to the drain outlet fitting on the ice-maker. Use a cable tie to secure it once fitted to prevent leakage.
- This appliance utilises a gravity-fed drainage system. Therefore, the drainage outlet pipe must be positioned a minimum of 100mm below the level of the appliance's drain pipe hole, ensuring a downward trajectory for effective water flow.

- The water pressure must be between 2 and 4 bar.
- Plug the power cord into a dedicated power source, then press the on/off switch to start the ice-making process. The green “run” light will be lit, and the ice-maker will start to operate.
- The operation of the ice-maker is completely automatic.
- If the 3.5Kg ice storage bin is full with ice, the “ice full” indicator on the display panel will be lit up, and the ice-maker will stop automatically.
- Remove the ice from the ice storage bin and then the ice-maker will restart automatically after a short while.
- Should the water supply to the appliance be insufficient, the “water low” light indicator will light up. The ice-maker will stop automatically.
- When the water supply is restored, the ice-maker will restart automatically again after a short while.

STRUCTURE

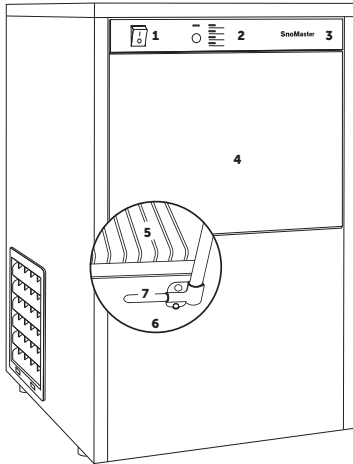

- 1** Power Switch
- 2** Display Panel
- 3** Front Panel
- 4** Storage Bin Door/Lid
- 5** Ice Grid
- 6** Ice Storage Bin

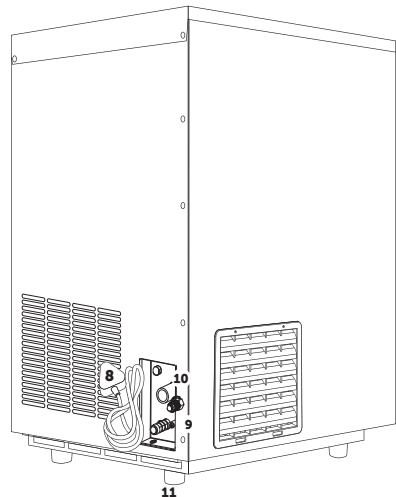

- 7** Ice Full Sensor
- 8** Power Cord
- 9** Water Inlet Valve
- 10** Drainage Outlet
- 11** Leveling Feet

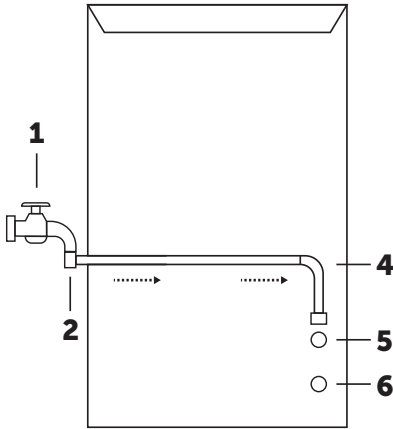

INSTALL THE WATER INLET SYSTEM AS FOLLOWS:

- 1 Tap
- 2 Water Filter Inlet Pipe
- 3 Water Filter Outlet Pipe
- 4 Water Inlet Valve
- 5 Drain Outlet

(Drain Outlet Must Be 100mm Lower Than The Appliance)

*Arrows Indicate Direction Of Water Flow

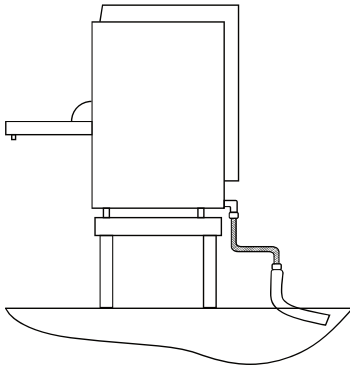

INSTALLING THE DRAIN

Note: This model drains via gravity – no drain pump supplied. An optional drain pump is required if installing this unit lower than the drain standpipe.

Ensure the end of the drainage pipe is situated lower than the Water Outlet valve for efficient drainage.

- Connect one end of the corrugated outlet hose to the water outlet on the rear of the ice maker.
- Attach the other end of the hose to a plumbed-in stand waste pipe or container suitable for collecting waste water.

INSTALLING THE COLD WATER FEED

Note: The optimal temperature for the water to be used: 10°C

- Place the sealing washers on the water inlet at the back of the ice maker and attach one end of the inlet hose.
- Connect the other end of the inlet hose to the water supply.

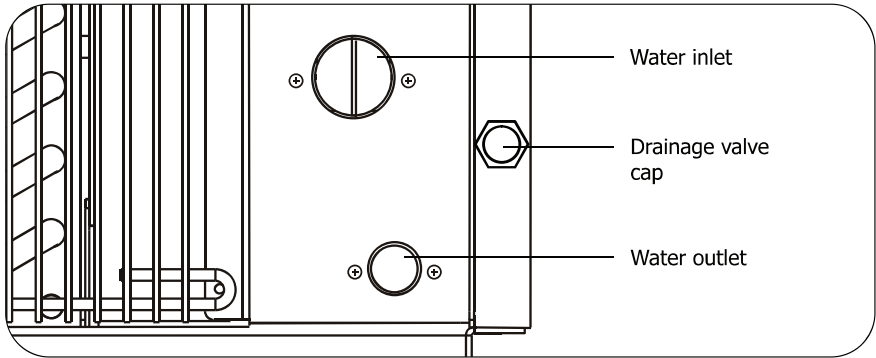

CONTROL PANEL

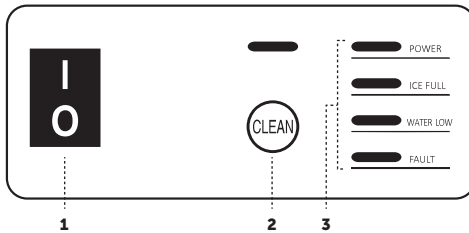

- 1 Power On/off Button
- 2 Clean Button
- 3 Function Indicator Light

OPERATION

MAKING ICE

Note: Before using the appliance for the first time (or after a period of inactivity), clean the water tank, ice basket and ice basket shelf. Use the first ice making cycle to flush out the system. Discard the water and ice created from the first cycle.

1. Ensure the door is closed fully before use.
2. Press the Power switch to the On position [I]. The POWER light illuminates and the appliance begins the ice making process. Each ice making cycle takes approximately 25 minutes.
3. When the ice bullets reach the ice sensor, ice production stops. Production resumes once ice has been removed from the bin.
4. Press the Power switch to the Off position [O] at any time to halt the ice making process.

Note: Ensure metal rack is pushed as far forward as possible against plastic ice curtain to allow ice to fall

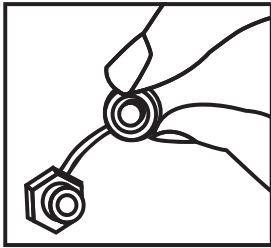

CLEANING, CARE & MAINTENANCE

- 1.** Always switch off and disconnect the power supply before cleaning.
- 2.** Warm, soapy water is recommended for cleaning. Cleaning agents may leave harmful residues. **DO NOT** wash the base unit, instead wipe the exterior with a damp cloth.
- 3.** Clean the water filter regularly with a small brush, particularly in hard water areas. The water filter is located just inside the water inlet at the back of the appliance.
- 4.** If the Ice Maker left unused for longer than 24 hours, loosen the drain valve cap and drain the water from the tank.
- 5.** The inner removable parts and water tank should be cleaned regularly.

AUTOMATIC CLEANING FUNCTION

This Ice Maker features an automatic cleaning function. When the appliance has completed up to 1500 ice-making cycles (roughly after 3-month routine use), the **"CLEAN"** indicator light will flash with audible alarm, indicating the unit needs to be cleaned. It will keep flashing and alarming until auto-cleaning is started, during which ice can still be made.

- 1.** Press and hold the **"CLEAN"** button for 3 seconds. The **"CLEAN"** indicator light will stop flashing and illuminate. The water box at the top will turn down and up. When it returns to vertical position, press the power switch to **0** (OFF position) and unplug the machine. Make sure no water remains in the water box.

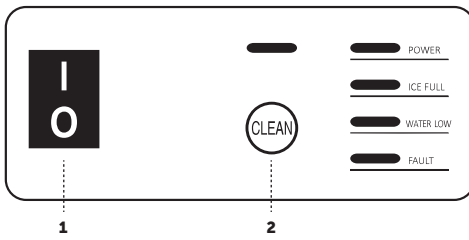

- 1 Power On/off Button
- 2 Clean Button

2. Unscrew the drainage valve cap at the right lower part at the rear. Let the water drain from the water reservoir thoroughly. Afterwards, relocate the drainage cap and screw tight.

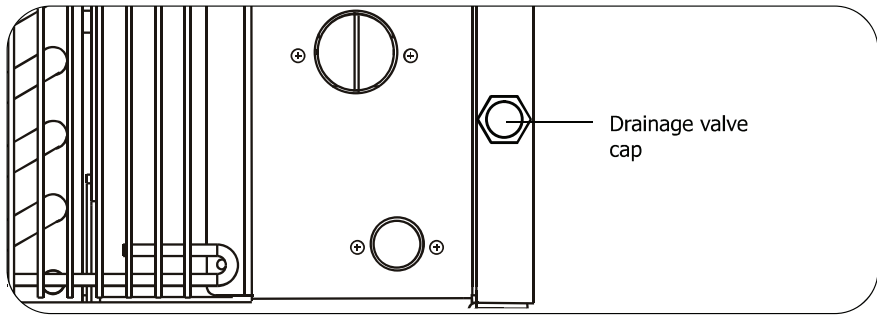

3. Add diluted cleaner into the reservoir (about 3L). **Note:** Choose ice maker specific cleaner and follow the manufacturer's instructions.

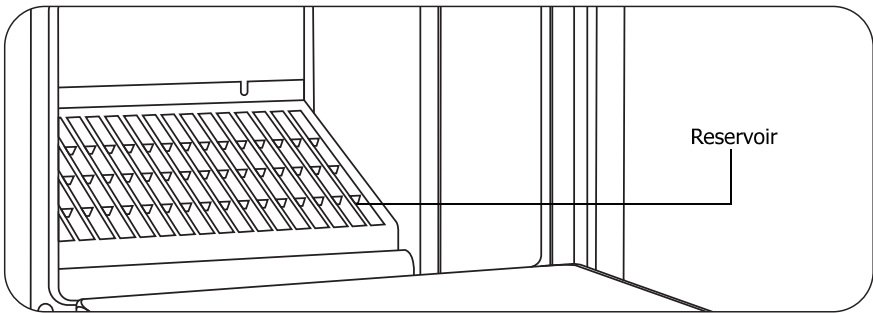

4. Plug in the appliance and press the power switch to I (ON position). The "CLEAN" indicator light will flash again.
5. Press and hold the "**CLEAN**" button for 3 seconds. The "**CLEAN**" indicator light will stop flashing and illuminate. The cleaner in the water reservoir will be pumped into the water box to start cleaning. After about 10 minutes, the water box turns to vertical to drop the cleaner. The appliance will repeat the above procedure two further times.

6. Turn the unit off and unplug. Remove the drainage valve cap to empty the water reservoir. When the unit is turned on again, the **"CLEAN"** indicator light will not light or flash, indicating the whole auto-cleaning is completed. **Note:** A cycle takes about 30 minutes.

Note: If the **"WATER LOW"** indicator light illuminate during cleaning, it means the water box is in lack of water and cleaning fails. In this case, turn the unit off. After the **WATER LOW** indicator light goes out, turn the unit on again. Then fill the reservoir with cleaner and repeat step 5.

After auto-cleaning, use the first 3 ice making cycles to flush out the system. Discard the water and ice created from these initial cycles.

DESCALING

1. In hard water areas lime scale can build up within the appliance after prolonged use. We suggest installing a water softener before inlet of water in case the supplied water is hard. The softener could be a mechanical filter.
2. To descale, always choose a suitable descaler and follow the manufacturer's instructions.
3. SnoMaster recommends that this appliance is descaled every 3 months or more frequently in hard water areas

-
- Wipe the interior dry and use a damp cloth with warm water and a mild detergent. Avoid using any abrasive chemicals.
 - Replace the filter cartridge periodically, depending on usage and water quality.
 - Clean the ice full sensor regularly.
 - For extended periods where the appliance will not be in use, ensure that the interior is completely dry, the water reservoir is completely drained.

SURGE PROTECTOR PLUG

To protect the appliance from electrical surges, it is advised to use a surge protector plug.

(Please note that this must be purchased separately and is not supplied with the appliance.)

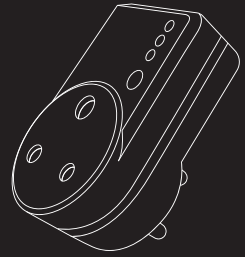

External Cleaning









- Dust the compressor at the back of the appliance with a brush or vacuum cleaner periodically, as dust build-up may affect the performance of the appliance.
- Avoid using sharp objects, high-pressure water jets or abrasive materials when cleaning the appliance.
- It is advisable to use a silicon based stainless steel polish cleaner to clean the exterior of the appliance.

ENERGY SAVING TIPS

Place the appliance in the coolest area of the room, away from any heat-producing appliances and out of direct sunlight.

TROUBLESHOOTING

Should you experience any issues with your appliance and the below troubleshooting tips do not resolve the fault experienced, kindly contact SnoMaster Service Department or your nearest accredited Service Agent:

Fault		Probable Cause	Solution
The appliance is not working		The unit is not switched on	Check the unit is plugged in correctly and switched on
		Plug or lead is damaged	Replace plug or lead
		Fuse in the plug has blown	Replace the fuse
		Mains power supply fault	Check mains power supply
		Ambient temperature below 10°C	Move appliance to a warmer position
		Water supply fault	Check water supply is on and supply hoses are not blocked
Appliance is noisy or works intermittently		Water supply fault	Turn off the ice maker and restart after 3 minutes
Compressor runs but no ice is made		Refrigerant leak or block in the refrigerant system	Call SnoMaster agent or qualified technician
 WATER LOW	Water low light is On	Water not connected	Connect ice maker to water supply
		Water filter is blocked	Clean water filter and restart ice maker
		Water pressure too low	Water pressure should be between 2 and 4 Bar. Call plumber to check water supply
 ICE FULL	Ice Full light is On	Ice bin full	Empty the ice bin
		Room temperature is too low	Move the appliance to a warmer position
 FAULT	Fault light is On	Water box is blocked and cannot tilt Or, Motor system fault	Disconnect from the power supply. Remove some of the ice cubes and gently tilt the water box. Restart the ice maker after 3 minutes If problem still persists, Call SnoMaster Agent or qualified technician
 FAULT	When unit on, fault light flashes once every 6s	Ice sensor fault, cannot make ice	Check if ice sensor is connected properly. If normal, call SnoMaster agent or qualified technician
	When unit on, fault light is On but "RUN" light Off		
 FAULT	When unit on, fault light flashes twice every 6s	Ambient temperature sensor fault, cannot make ice	Check if ambient temperature sensor is connected properly. If normal, call SnoMaster agent or qualified technician
 ICE FULL	When unit on, ice full light is On but "RUN" light Off		
 FAULT	When unit on, fault light flashes thrice every 6s	Water temperature sensor fault, cannot make ice	Check if water temperature sensor is connected properly. If normal, call SnoMaster agent or qualified technician
 WATER LOW	When unit on, water low light is On but "RUN" light Off		



ICE COLD ANYWHERE

**JOHANNESBURG LIFESTYLE
CENTRE & SERVICE CENTRE**

49 Koornhof Road
Meadowdale
Germiston, 1614
011 392 5315 / 3147
info@snomaster.co.za

**CAPE TOWN LIFESTYLE CENTRE
& SERVICE CENTRE**

31 Stella Road
Montague Gardens
Cape Town, 7441
021 100 5695
info@snomaster.co.za

snomaster.co.za



@SnoMasterSA



SnoMaster SA



snomaster_south_africa



@SnoMaster