

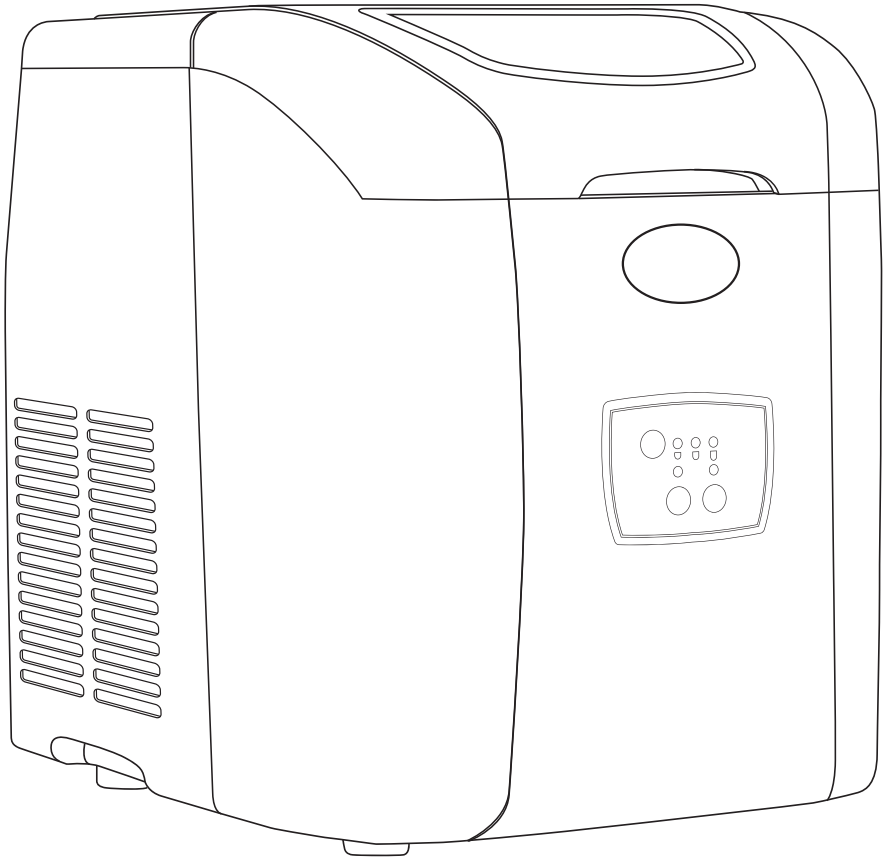

**USER MANUAL
AND PRODUCT
SPECIFICATIONS**

ICE COLD ANYWHERE



ZB-14R/G/B

**12KG COUNTER-TOP
ICE-MAKER**

CONTENTS

WARRANTY, SERVICE AND SUPPORT	01
Warranty Registration	
Service and Support	
IMPORTANT SAFETY INFORMATION	02
Before Using Your Appliance	
Critical Safety Information For Your Safety	
INSTALLATION INSTRUCTIONS	04
Water	
Accessories Included	
Control Panel	
MAINTENANCE	07
Cleaning the Interior	
Cleaning the Exterior	
ENERGY SAVING TIPS	07
TROUBLESHOOTING	08
PARTS LIST	11



**THANK YOU FOR PURCHASING THE ZB-14R/G/B,
12KG COUNTER-TOP ICE-MAKER**

• WARRANTY, SERVICE AND SUPPORT •

This product is warranted for **5 years on the compressor, 3 years on the unit and 1 year on all parts not listed from the date of purchase**. Warranty does not cover products that have not been used in accordance with the user guide or are outside the warranty terms and conditions, which can be found at the following url:
<https://snomaster.co.za/warranty/>

WARRANTY REGISTRATION

Register your SnoMaster ZB-14R/G/B, 12Kg Counter-Top Ice-Maker now for warranty, and allow us to provide you with the best possible after sales service:

- Please log onto our website at **www.snomaster.co.za**
- Click on the 'Warranty' tab.
- Enter warranty information and upload proof of purchase at the bottom of the page.

SERVICE AND SUPPORT

Should an instance arrive where you require assistance, contact our service team:

- Please log onto our website at **www.snomaster.co.za**
- Click on the 'Support' tab.
- Click 'Find a Repair Agent Near You' and enter your region.
- Alternatively contact us via email: **info@snomaster.co.za** or contact us on **+27 11 392 5315**.

IMPORTANT SAFETY INFORMATION

ZB-14R/G/B, 12KG COUNTER-TOP ICE-MAKER

This manual contains important information including safety, installation, maintenance and warranty instructions of the SnoMaster ZB-14R/G/B, 12Kg Counter-Top Ice-Maker.

Please read this manual carefully before use and follow all safety information and instructions. It is recommended to keep this manual for easy reference so that you are familiar with the operation and maintenance of your appliance.

CRITICAL SAFETY INFORMATION FOR YOUR SAFETY

Before using this appliance, ensure it is correctly positioned and installed as outlined in this manual. Follow these basic precautions to prevent the risk of fire, electrical shock, or injury:

- This appliance is designed for domestic indoor use only and is exclusively intended for making ice.
- Ensure that the incline angle of the appliance is not more than 45° during transportation or operation.
- Before using your appliance for the first time, you should wait about 12 hours after positioning it in a place.
- The appliance needs to be levelled for optimal operation. You can adjust the appliance feet to level it +/- 10mm.
- Ensure the plug is easily accessible after positioning the appliance.
- Avoid connecting or disconnecting the electric plug with wet hands.
- To disconnect the appliance, grip the plug and pull it from the wall outlet. Never pull out the plug by the cord.
- It is advisable to use a dedicated power source and avoid using extension cords.

- Please unplug the appliance or disconnect the power before performing any cleaning, maintenance, or servicing.
- If the appliance power supply cord is damaged, it must be replaced by SnoMaster, its approved agent, or a similarly qualified person to prevent any hazard.
- It is recommended that the circuit breaker size should be no more than 20 amps.
- This appliance operates on a single-phase voltage of 230V/50Hz, to avoid electrical surges, it is advised to use a surge protector plug.
- Cleaning and maintenance should be supervised by adults, especially if children are involved.
- The appliance should be placed on a flat surface and should be completely unobstructed. Ensure to leave 150mm space around the appliance to ensure proper ventilation for the appliance. Place the appliance away from direct sunlight and heat sources (stove, heater, radiator, etc.).
- Unless specifically recommended in this manual, do not attempt to repair or replace any part of the appliance. All other servicing should be referred to a qualified technician.
- Never clean appliance parts with flammable fluids as they may create a fire hazard or explosion. Also, avoid storing or using petroleum or other flammable vapours and liquids near this appliance.
- Avoid solvent-based cleaning detergents or abrasives on the interior or exterior as they may damage or discolour it.



This appliance contains CYCLOPENTANE and R600a refrigerant , which is FLAMMABLE and may cause a fire or an explosion.



WHEN DISPOSING THE APPLIANCE

Please observe the following instructions:

- Always ensure the appliance is out of reach of children. Before disposing of it, damage the body.
- Follow the instructions of your local regulations when disposing.

PRODUCT FEATURES

10 CUBES PER CYCLE | PORTABLE | AVAILABLE IN RED, GREY OR BLACK

SPECIFICATIONS:

- **Dimensions (mm) Unit:** (H) 380 (W) 310 (D) 385
 - **Storage Volume:** 0.8Kg
 - **Net Weight:** 13.5Kg
 - **Ice Making Capacity:** 12Kg/24h
 - **Voltage:** 220-240V/50Hz
 - **Total Input Power:** 100W
 - **Dimensions (mm) Packaged:** (H) 420 (W) 455 (D) 365
 - **Rated Current:** 0.7A
 - **Suggested Applications:** Office, Apartment, Kitchen, B&B, Home Bar
 - **Design Criteria:** Engineered for the African Climate
-

INSTALLATION INSTRUCTIONS



Before installing your new appliance, please read all safety instructions in this manual and follow the installation instructions below:

- Remove the appliance from the box, ensure all packaging materials, stickers and films are removed from the product. Clean the appliance's surfaces with a mild detergent and a damp cloth before initial use.
- Clean the inner liner, ice basket, water storage tank, water box ice pusher and evaporator with a mild detergent and damp cloth before initial use.
- Ensure the appliance is placed on a level, sturdy surface.
- **Caution:** Installing the appliance on carpeting may lead to discoloration due to heat emission from the compressor.
- Ensure adequate air circulation for the appliance by maintaining a clearance of at least 150mm on all sides.

WATER

- Water treated with reverse osmosis purification often gives a false water indicator. You can add a pinch of salt to correct this, or rather use filtered mineralized water.
- Ice cycle time is dependent on water temperature.
- Clean and drain the appliance at least once or twice a month. Lemon juice or 10ml vinegar can be added to the water to help the cleaning process.
- To prevent lime build-up it is advised to clean the appliance with a descaling liquid once a month, dependent on the water quality in your area.

ACCESSORIES INCLUDED

Please Check If All The Accessories Shown Below Are Included:

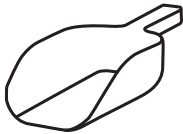

1 x ICE SCOOP

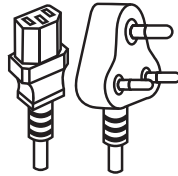

1 x 220V POWER CORD

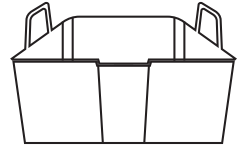

1 x ICE BASKET

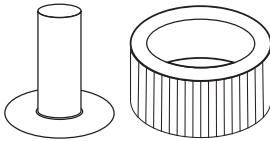

1 X DRAIN CAP
WITH SILICON
GROMMET

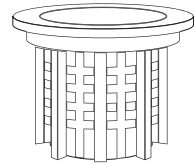

1 x FILTER

SURGE PROTECTOR PLUG

To avoid electrical surges, it is advised to use a surge protector plug. (Please note that this must be purchased separately and does not come with the unit.)

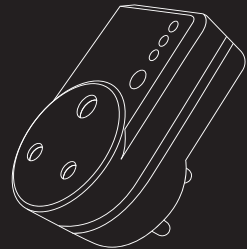

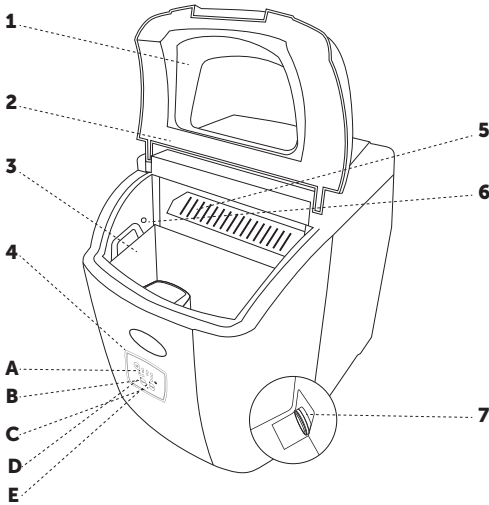

STRUCTURE

- 1 Lid
- 2 Inner Liner
- 3 Ice Basket
- 4 Control Panel
- 5 Ice Pusher
- 6 Ice Full Sensor
- 7 Filter

-
- A Select Ice Size
 - B Start Ice Making Cycle
 - C Stop Ice Making Cycle
 - D Ice Full Indicator
 - E Water Low Indicator
-

OPERATION PROCEDURE

- Place the Ice Basket inside the appliance.
- Ensure that the water drain cap is secure with the silicone grommet inside.
- Fill the water tank with drinkable water only, ensuring that the water level does not exceed the bottom of the ice basket.
- Connect the appliance to a dedicated power source.

CONTROL PANEL

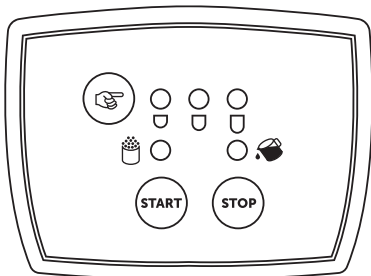

- The green indicator light will flash until the **ice bullet size** has been **selected** and the start button has been pushed.
- Let the ice-maker run a few cycles so that it can fully calibrate.
- Once this has all been done, the ice-maker will start to produce ice.

- The appliance will now start producing ice. *Time between ice making cycles will vary depending on the ambient and water temperature.
- To change the ice bullet size, press the 'Select' button to choose your bullet ice size preference.
- When the ice basket is full, the 'Ice' indicator light will illuminate. You can either remove ice and store, or the ice will melt into the water tank for water recycling.
- When the water level is low or water tank is empty, the 'Add Water' indicator light will illuminate. You will need to add water to water tank.

SWITCHING THE APPLIANCE OFF:

- Wait for the current ice cycle to finish and press the 'Stop' button.
- Unplug the appliance from the power source.

MAINTAINENCE

To ensure safety, remember to always disconnect the appliance from the power supply before performing any form of maintenance or cleaning.

INTERNAL CLEANING

- Empty the water tank using the drain plug and store the drain cap with silicone grommet in a safe place while doing this.
- Remove the inner filter and ensure the filter is free of any debris.

DRAIN CAP WITH SILICON GROMMET

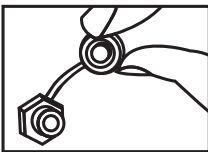

FILTER

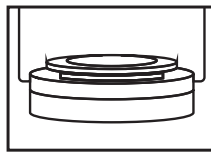

WATER SENSORS

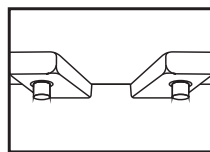

ICE-FULL SENSOR

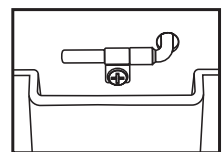

- Wipe the interior dry and use a damp cloth with warm water and a mild detergent. Avoid using any abrasive chemicals.
- Ensure that the interior is completely dry with no water inside.
- Clean the interior filter regularly (at least once a month) as well as the 'ice-full' and 'water sensors'.

IF THE APPLIANCE IS USED CONSISTENTLY, ENSURE THE WATER IS CHANGED ONCE A WEEK TO PREVENT ALGAE BUILD UP.

EXTERNAL CLEANING

- Dust the compressor at the back of the appliance with a brush or vacuum cleaner periodically, as dust build-up may affect the performance of the appliance.
- Avoid using sharp objects, high-pressure water jets or abrasive materials when cleaning the appliance.
- It is advisable to use a silicon based stainless steel polish cleaner to clean the exterior of the appliance.

ENERGY SAVING TIPS

Place the appliance in the coolest area of the room, away from any heat-producing appliances and out of direct sunlight.

TROUBLESHOOTING

Should you experience any issues with your appliance and the below troubleshooting tips do not resolve the fault experienced, kindly contact SnoMaster Service Department or your nearest accredited Service Agent:

PROBLEM	PROBLEM POSSIBLE CAUSE / MEASURE
Ice-maker is not turning on	<ul style="list-style-type: none">• Check if the ice-maker is correctly switched on.• Check if there has not been loadshedding or a power cut.• Check if plug is not faulty or damaged.• Check if voltage is correct.• Make sure you have followed the installation requirements correctly.
Ice-maker is only producing small or medium ice	<ul style="list-style-type: none">• The first few cycles could take 13 to 16 minutes per cycle, depending on the ambient temperature. Move the ice-maker to a cooler area, out of direct sunlight.• Water pump is faulty and needs to be repaired or replaced.
Moisture forms on the inside/ outside walls of the ice-maker	<ul style="list-style-type: none">• Hot and humid weather usually in the coastal locations increases the internal rate of condensation. This is normal.• Condensation may occur seasonally depending on humidity and ambient temperature.• Open the lid less frequently and ensure it is closed properly at all times.

TROUBLESHOOTING

PROBLEM	PROBLEM POSSIBLE CAUSE / MEASURE
Exterior of ice-maker is wet	<ul style="list-style-type: none"> • Condensation will form on the outside of the ice-maker if it operates in humid areas or in the rainy season, simply wipe it dry with a non-abrasive cloth.
The power indicator light is on and the compressor is working abnormally with a buzzing noise	<ul style="list-style-type: none"> • The voltage is too low. • Restart the ice-maker after 3 minutes to not damage the compressor.
"Water Low" indicator light is on	<ul style="list-style-type: none"> • Fill ice-maker with water and it will restart to work automatically. • Add a pinch of salt if using reverse osmosis water. • Clean the water level sensor screws with fine grit sandpaper.
"Ice Full" indicator light is on	<ul style="list-style-type: none"> • Ice basket is full. Remove some ice. • Temperature inside is too low and only deactivates if above 10 degrees move to warmer area. • Use lukewarm water.
The 'Ice Full' and 'Water Low' indicator lights flicker simultaneously	<ul style="list-style-type: none"> • Power off the ice-maker and check the interior for any obstructions or ice that could be blocking the ice pusher. Restart the appliance after 3 to 5 minutes. • While the ice-maker is turned off, recalibrate the ice-maker by gently pushing the ice pusher into the default resting position and then restart the ice-maker after 3 to 5 minutes again. • The water box motor is faulty and needs to be repaired/replaced.
Compressor is running but no ice is being made	<ul style="list-style-type: none"> • Remove the filter and check if there is any debris blocking the filter. • Check if the fan is working. • The solenoid valve needs to be replaced.
The control panel lighting does not work	<ul style="list-style-type: none"> • Ensure the ice-maker is plugged in to a dedicated power source. • Check the interior for any obstructions or ice that could be blocking the ice pusher. Restart the ice-maker after 3 to 5 minutes. • The fuse on the main relay board needs to be replaced.

TROUBLESHOOTING

PROBLEM	PROBLEM POSSIBLE CAUSE / MEASURE
Ice is not forming	<ul style="list-style-type: none">• Possible gas leak.• Replace filter drier.
Ice is forming a solid block	<ul style="list-style-type: none">• The water temperature is too low, move the ice-maker to a warmer area or use luke warm water.• The ice timer is faulty.• The condenser sensor is faulty and needs to be replaced.• Select smaller ice size options.

ZB-14 LIST OF PARTS

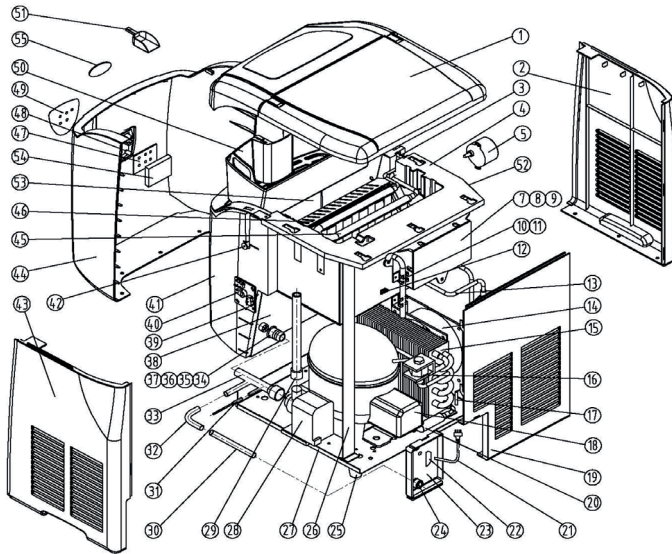

- | | | | |
|----|---|----|---------------------------------------|
| 1 | Lid | 31 | Sensor |
| 2 | Left Panel | 32 | Water Line |
| 3 | Evaporator Pressure Block | 33 | Silica Gel Four-way (Without Flaring) |
| 4 | Inner Liner | 34 | Drain Connector |
| 5 | Motor | 35 | Drain Nut |
| 7 | Power Box | 36 | Sealing |
| 8 | Power Box Cover | 37 | Filter Net |
| 9 | Water Inlet Controller | 38 | Infrabasal Plate |
| 10 | Water Injection Pipe | 39 | Limit Switch Plate |
| 11 | Water Injection Pipe Fixing Clip | | Microswitch |
| 12 | Cable Fixing Cover | | Microswitch Wire |
| | Cable Holder | 40 | Baffle Plate |
| 13 | Return Pipe Assembly R600a | 41 | The Tank Foam |
| 14 | Fan | 42 | Light Control Set |
| 15 | Condenser | | Ice Full Probe Firing Line |
| 16 | ZB-14 (R134a) Solenoid Valve Assembly | | Ice - Filled Probe Receiving Line |
| 17 | Sensor | | Ice Level Sensor (Receiver) |
| 18 | Compressor | | Ice Level Sensor (Launch) |
| 19 | Back Sealing Plate | 43 | Right Panel |
| 20 | Filter | 44 | Front Panel |
| 21 | Za South Africa 2.0 Meters With 90 Bend Plug Power Cord (Black) | 45 | Evaporator |
| 22 | AC Socket | 46 | Water Box |
| | Socket Cable | | Ice Pusher |
| 23 | Threading Plate | | Stainless Steel Pin |
| 24 | 10/14/pr Long Drain Connector | 47 | Display Board |
| | Drain Joint Cover | 48 | Operation Panel |
| | Drain Nut | 49 | Control Panel Sticker |
| | T Plug | 50 | Ice Basket |
| 25 | Feet | 51 | Ice Scoop |
| 26 | Rear Roof Gusset | 52 | Turning Motor Fix Board |
| 27 | Bottom Plate | 53 | Tilt Plate |
| 28 | Water Pump | 54 | Display Panel |
| 29 | Silicone Tube-1 | 55 | Snomaster Aluminum Logo |
| 30 | Silicone Tube-2 | | |



ICE COLD ANYWHERE

**JOHANNESBURG LIFESTYLE
CENTRE & SERVICE CENTRE**

49 Koornhof Road
Meadowdale
Germiston, 1614
011 392 5315 / 3147
info@snomaster.co.za

**CAPE TOWN LIFESTYLE CENTRE
& SERVICE CENTRE**

31 Stella Road
Montague Gardens
Cape Town, 7441
021 100 5695
info@snomaster.co.za

snomaster.co.za



@SnoMasterSA



SnoMaster SA



snomaster_south_africa



@SnoMaster